

G series

With the G series, you have the opportunity, to order enclosures of the SG, SB, PGS and TG series in various heights. We will deliver these enclosures short-term and in small number of pieces.

Combination of cover and bottom

Our large selection gives you the possibility to choose your own special enclosure.

Available tube profiles

Ba x La	Ba x La
30 x 40 mm	60 x 60 mm
	60 x 80 mm
40 x 30 mm	60 x 100 mm
40 x 40 mm	60 x 120 mm
40 x 50 mm	60 x 140 mm
40 x 60 mm	
40 x 80 mm	80 x 80 mm
40 x 100 mm	80 x 100 mm
40 x 120 mm	80 x 140 mm
40 x 150 mm	80 x 150 mm
40 x 180 mm	80 x 160 mm
	80 x 200 mm
	80 x 220 mm
50 x 40 mm	
50 x 50 mm	100 x 100 mm
50 x 60 mm	100 x 150 mm
50 x 80 mm	100 x 200 mm
50 x 100 mm	
50 x 120 mm	
50 x 150 mm	
50 x 180 mm	
50 x 200 mm	

Configuration of model designation

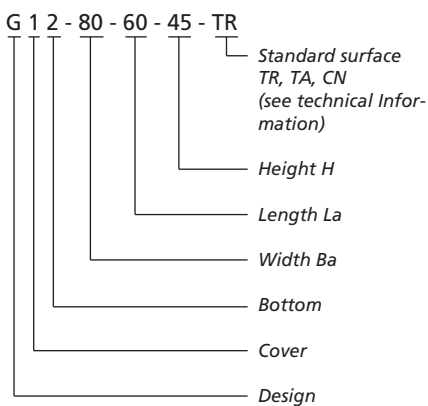

Dimensions, G series

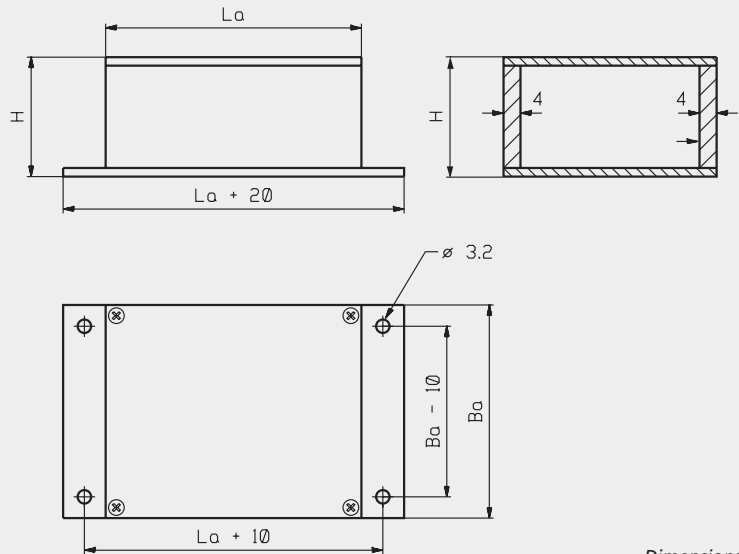

Dimensions in mm

Cover and bottom plate versions

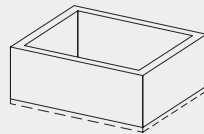

Type 0
Enclosures without mounting drill holes, cover and bottom plate

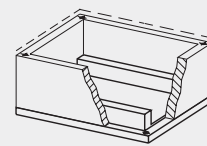

Type 5
3 mm thick screwed profile cover or bottom plate

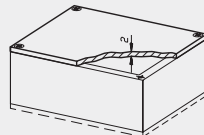

Type 1
2 mm thick screwed cover and bottom plate.

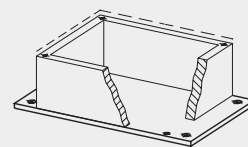

Preferred type 6
Screw mounted, flat exceeding bottom plate (2 mm thick) with mounting holes (\varnothing 3,2 mm)

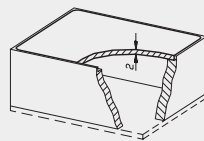

Type 2
Inlay cover and bottom plate

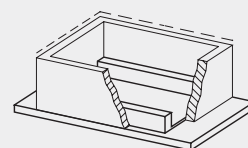

Preferred type 7
3mm thick exceeding profile cover or bottom plate

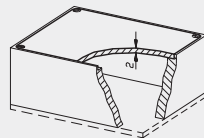

Preferred type 3
Inlay screwed cover and bottom plate

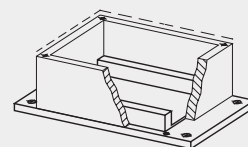

Type 8
Screwed exceeding 3mm thick profile cover or bottom plate with mounting holes (\varnothing 3,2 mm)

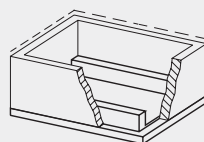

Preferred type 4
3 mm thick profile cover or bottom plate

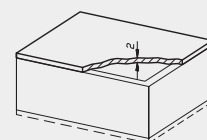

Type 9
2mm thick flat cover or bottom plate.

Do you desire a large amount of mounting screws or do you need other positions?
Please call us!

Profiles

Precision profiles

Material: aluminum base alloy
Tolerance after DIN 17615

Cover profiles P 40 – P 100

Like the SG, SB, TG and G series

Side-piece profiles SP 1 – SP 4

Like KG, KGT, EG and EGD series

Dimensions of structure

Cover structure P 40 – P 100

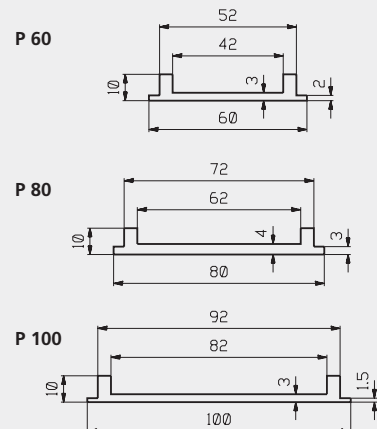
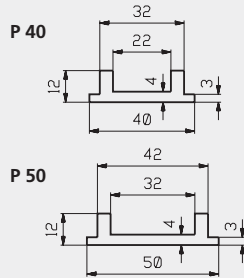

Side-piece profiles SP 1 – SP 4

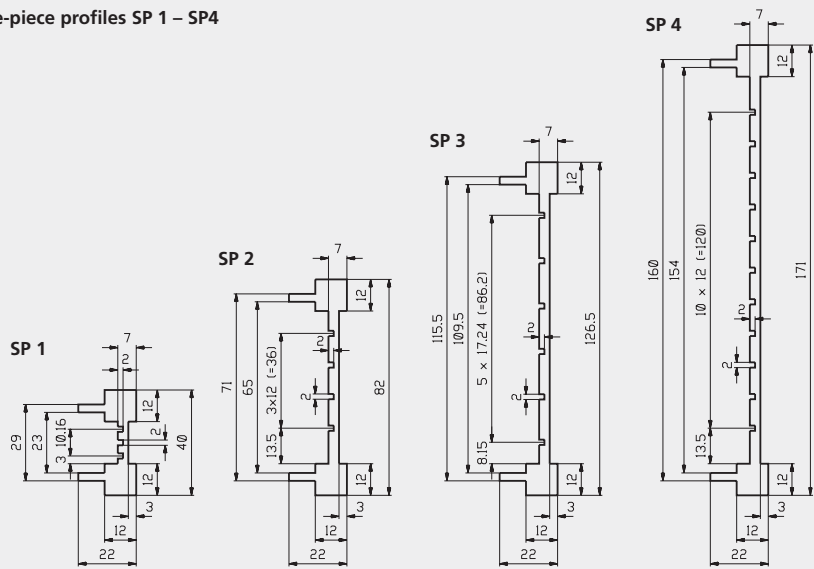

Dimensions in mm